

General

Productgroup LF PowerTwo
Mounting type Pressfit Techn
Material Brass lead-free (max. 0.1% Pb)
Surface tin
Customs tariff number
Country of origin Federal Republic of Germany
Weight per pieces ~ 0.005000 kg

Technical data

Terminal / Type Buchse Durchgang / Diameter
Thread/Diameter x Length 8.200 mm x 8.40 mm
Torque 0.00 Nm

Pressure plate length x width 16.000 mm x 16.00 mm
Pressure plate height 2.00 mm
Height total 8.40 mm
Pin length 6.40 mm
Pin alignment knurl
Push in area for diameter 10.50 mm
Push in length 3.50 mm up to 6.40 mm

Processing

Notice

Usage and storage

Temperature -40°C up to +150°C
Storage dry environment protected from weather conditions
Storage conditions at +5°C up to +40°C, 75% RH, non-condensing

Packaging

packaging quantity 0.000 pcs

Accessories

Press in tool

Standard drill pattern

Drill hole specification for PCB

Dimensions

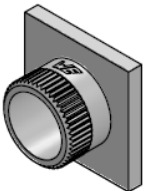
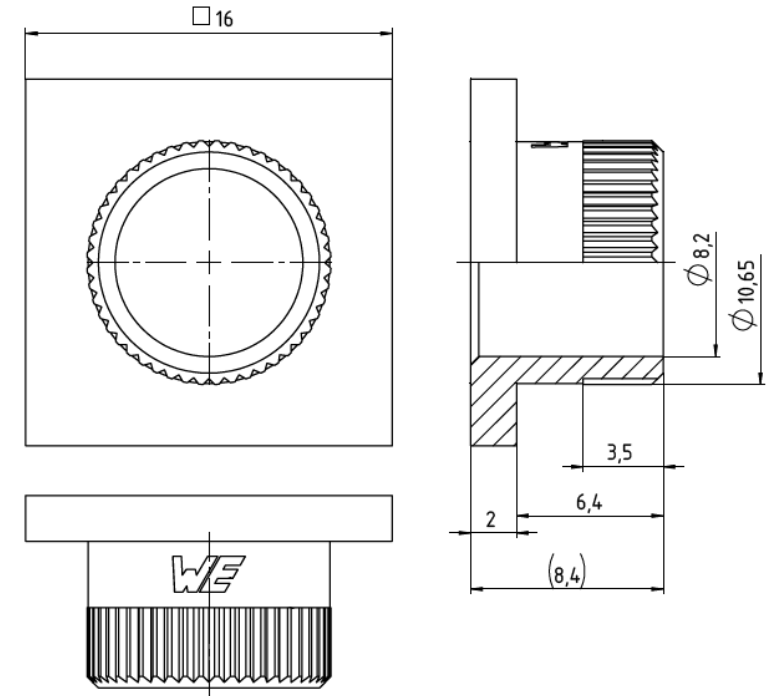

Würth Elektronik ICS GmbH & Co. KG
Würthstraße1 74676 Niedernhall, Germany
P +49 7940 9810-4444 lf-powerelement@we-online.de
www.lf-powerelement.de

Observe protective note ISO 16016. Passing on or duplication without previous written agreement forbidden. Violations oblige to compensation. All rights reserved in the event of a patent or utility model protection. Subject to change without notice! Is NOT subject to change service!

Generaltolerances

DIN ISO 2768-mH

Projection mode



Revision	Date	All measures in
A	08.06.21	mm

Part no.

LF990482

Description

LF PowerTwo Push in Element Bush

